



The reflection
of 100 years
of expertise



Windows • Steel Doors • Patio Doors
roberge1917.com

THE REFLECTION OF 100 YEARS OF EXPERTISE

In 1917, Alexandre Roberge started his modest company in La Sarre, Abitibi-Témiscamingue. Skilled with his hands and passionate about work that was well done, he crafted wooden doors and windows by hand.

In 1950, Roberge became the most important company of its kind in Abitibi-Ouest. It was also in 1950 that Mr. Roberge's son, Jean-Guy, then 20 years old, joined his father in the family business. He later bought it **in 1960**. A formidable challenge lay ahead for the young 30-year-old man. With the same passion, he set up a production line for doors and windows as well as a distribution network throughout the Abitibi-Témiscamingue and Northeastern Ontario regions.

Toward the **end of the 1970s**, the infectious enthusiasm of the Roberge family extended to the third generation, when the two grandsons,

Pierre and Gaétan, joined the company. Since then, the modernization of the door and window factory has made it possible to deliver a product that is continually better suited to the rigors of the Quebec climate.

Between 1999 and 2011, the company opened two sales branches: the first in Gatineau, the second in Nepean. Today the company contributes to the Quebec economy by creating more than 100 jobs.

In 2016, the company was acquired by local entrepreneurs who have in their hearts the local economy, the regional products, and their greatest asset, their employees, who do an outstanding job each and every day. **In 2017**, Roberge celebrated its 100th anniversary.





Roberge started its operations in Abitibi more than 100 years ago. Our company's success comes from our highly effective products developed by our dedicated team.



Bruno M.
A true craftsman for the past 35 years at Roberge

**PROUDLY
CRAFTING
YOUR
COMFORT**

WHY CHOOSE ROBERGE WINDOWS?



- \ BECAUSE THEY'RE THE **BEST** WINDOWS ON THE MARKET
- \ BECAUSE THEY'RE SPECIALLY DESIGNED FOR OUR **NORTHERN CLIMATE**
- \ BECAUSE THEY MEET THE **HIGHEST QUALITY STANDARDS** IN THE INDUSTRY
- \ BECAUSE THEY'VE BEEN MANUFACTURED BY TRUE CRAFTSMEN **FOR OVER 100 YEARS** IN ABITIBI
- \ BECAUSE THEY'RE ALL AVAILABLE WITH **TRIPLE PANE**

**PROUDLY
CRAFTING
YOUR
COMFORT**

STYLE

- \ Wide selection of window **models** (casement, awning, sliding, hung, fixed or architectural)
- \ High-quality **materials** (all-PVC and PVC/ aluminium)
- \ Colonial or contemporary **designs**
- \ Wide range of **colors** for matching your windows to your home's exterior finishing
- \ **Retrofits** or new **construction**
- \ Unique white gloss **finish** for easy cleaning
- \ Highest quality of **paint**
- \ **Black spacer** that **enhances** the aesthetic appeal of the window
- \ Wide choice of **grills** to match your style

QUALITY

- \ **Three choices of thermopanes:**
 - 7/8" double glass with Low-E and argon gas
 - 1 1/4" triple glass with Low-E and argon gas
 - 1 1/4" triple glass with two Low-E and argon gas
- \ **Customised thermopanes** (Frosted, sandblasted or tinted finish, glue chip, safety glass, etc.)
- \ **Maximum insulation** (High performance PVC multi-chambered design)
- \ **Thermopane mould on the inside** (Better performance)
- \ **Opening-limiting device** available for added safety (casement, sliding, and hung)
- \ Wide selection of **brickmoulds**
- \ Built-in 1/2" and 3/4" **drywall** return (for easy installation of multiple interior moulds)
- \ Metal **fasteners** attached to all our windows (easy installation)
- \ **High-quality hybrid product** (thicker aluminium, crimped corner, and flawless finish)

WINDOWS



CASEMENT AND AWNING



Casement

Awning

4000 SERIES

Windows that meet the needs of your retrofit and new construction projects.

Choice of **four all-PVC frames and two hybrid frames**, paintable on the inside and outside.

Structural window for a larger viewing area.

Full 90-degree opening of the operating sashes to make cleaning the outside surface easier.

Triple weather stripping on the sash consisting of a series of three airtight and watertight barriers (gaskets will not stretch or shrink and are completely replaceable in the event of accidental damage).

Multipoint lock fitted with a 1 to 5 point stainless steel bar attachment, according to dimensions, providing maximum tightness and greater structural integrity.

Heavy-duty TRUTH operator from the Encore series with retractable handle.

Solid steel lock-and-keeper system (increases performance and provides maximum intrusion protection).

Triple-pane glass available for **all frames**

Screen built with a coextruded aluminium frame—no corners or handles, no yellowing, greater durability, and better adhesion to the window frame.



PVC

4406 – 4 5/8"

Quality, performance, price

Design: colonial

Brickmould integrated in the frame (eliminates the risk of water infiltration)

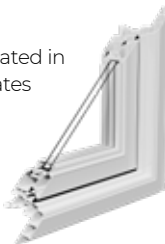

4607 – 6 1/2"

Best quality, best performance

Design: colonial

Brickmould integrated in the frame (eliminates the risk of water infiltration)

Thermopane in the warmest part of the wall (increased condensation resistance)



4402 – 4 5/8"

Retrofit or new construction, possibility of installing from the inside, price

Designs: colonial and contemporary

Designed to accept multiple exterior brickmoulds



4602 – 6 1/2"

Maximum condensation resistance

Designs: colonial and contemporary

Thermopane in the warmest part of the wall (increased condensation resistance)

Designed to accept multiple exterior brickmoulds

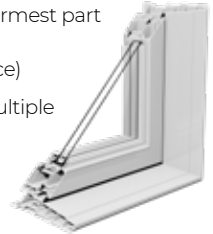

HYBRID

The warmth of PVC with the durability of aluminium

AL4402 – 5 1/8"

Designs: colonial and contemporary

Possibility of adding a colonial brickmould



AL4402MB – 6 1/4"

Design: colonial

Brickmould integrated in the frame (eliminates the risk of water infiltration)



SLIDING AND HUNG

2000 SERIES

Windows that meet the needs of your retrofit, new construction, and self-build projects.

Choice of **three all-PVC frames and two hybrid frames** paintable on the outside only.

Triple weather stripping (oversized at rails) for maximum weather tightness.

Interlock lock and keeper system guarantees maximum security against intruders and creates a water tight seal.

Hung window equipped with a **system of counterweights to make the window easier to open and close.**

Triple-pane glass available for **all frames.**

Two Sliding Versions

- Sliding fitted with a tilting sash that tilts inward — The sash is fitted with chrome-plated tandem wheels for smooth movement.
- Sliding window fitted with a tilting system — The sash tilts inward for full frame ventilation as well as safe and easy cleaning.



Hung

Removable pane on rollers



Pivoting pane



PVC

2402 – 4 5/8"

Retrofit or new construction, possibility of installing from the inside, price

Design: colonial

One opening sash and one fixed thermopane

Designed to accept multiple exterior brickmoulds



2405 – 4 5/8"

Retrofit or new construction, possibility of installing from the inside, price

Design: contemporary

One opening sash and one fixed thermopane

Designed to accept multiple exterior brickmoulds

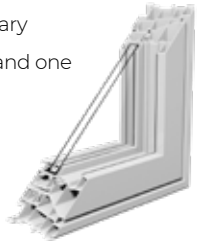

2607 – 6 1/2"

Significantly increases condensation resistance

Design: colonial

One opening sash and one fixed thermopane

Brickmould integrated in the frame (eliminates the risk of water infiltration)

Thermopane in the warmest part of the wall (increased condensation resistance)

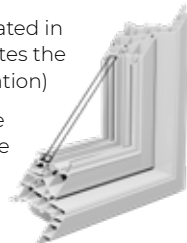

2403 – 4 5/8"

Product that matches well with any design (colonial or contemporary)

Two opening sashes (maximum ventilation)

Two sashes that incline and tilt to the inside (easy exterior cleaning)

Designed to accept multiple exterior brickmoulds

Removable sashes

Available in a version with rollers only

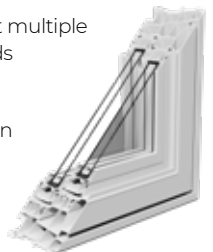

DESIGNS

Colonial



Contemporary



HYBRID

The warmth of PVC with the durability of aluminium

AL2402 and AL2405 – 5 1/8"

Designs: colonial and contemporary

One opening sash and one fixed thermopane



AL2402MB – 6 1/4"

Design: colonial

Brickmould integrated in the frame (eliminates the risk of water infiltration)

One opening sash and one fixed thermopane





Model for display purposes only

ARCHITECTURAL WINDOWS

ALL-PVC AND HYBRID WINDOWS

Choice of **4 all-PVC frames and 5 hybrid frames**, which blend perfectly with 4000 and 2000 series windows.

A number of architectural window models are available on our website.

Sharing the same standard features as the 4000 and 2000 series.

Available with **multiple options of interior and exterior moulds** from the 4000 and 2000 series.

Modular assembly for windows and doors for a range of possibilities.

* Also available with HYBRID aluminium cladding

PVC

4401 – 4 5/8" * Perfect for irregular shapes

Design: colonial

Shapes such as half-moon, circular arc, oval or circle as well as angular shapes (triangle, trapezoid, etc.)

Lets in more light than the 4409



4409 – 4 5/8" * Simulates a casement or awning window pane

Design: colonial

Angular shapes (trapezoid, triangle, hexagon, etc.)



4403 – 4 5/8" * Maximize the glass surface

Design: contemporary

Maximizes the glass surface in windows with angular geometric shapes (trapezoid, triangle, hexagon, etc.)

Lets in more light than the 4408



4408 – 4 5/8" * Simulates a casement or awning window pane

Design: contemporary

Angular shapes (trapezoid, triangle, hexagon, etc.)



HYBRID

High-end, the warmth of PVC with the durability of aluminium

3663 – HYB 5 1/8"

Design: colonial

Frame can be curved to create round shapes, such as a half-moon, a circular arc, an oval, an elongated ellipse, etc.



STANDARD FEATURES

SLIDING AND HUNG



Stainless steel retaining cap

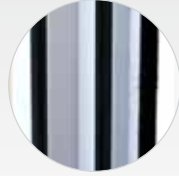

Triple weather stripping



White tango-style retractable handle

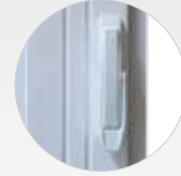

Multipoint lock (1 to 5 points)

CASEMENT AND AWNING



Tandem chrome-plated castors



Opening-limiting device (optional)

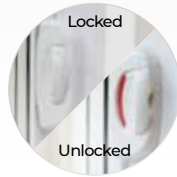

Interlock automatic lock

OPTIONS

EXTERIOR MOULDS



2" extension

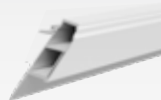

1 1/8" colonial brickmould



4" colonial brickmould



2" colonial brickmould

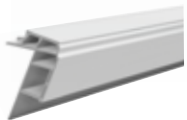

1 7/8" - 1 1/8" extended colonial brickmould



4" contemporary brickmould

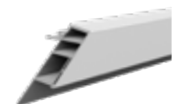

1 1/8" contemporary brickmould

SIMULATED DIVIDED LITES AND GRILLS

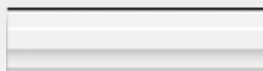

1 1/2" stylized PVC or colored aluminium simulated divided lite



2" contemporary PVC or colored aluminium simulated divided lite



3/4", 1" or 1 3/4" Georgian white or color grill



5/8", 1" or 2" flat white or color grill



White, tin, silver, or brass tubular grill

INTERIOR MOULDS

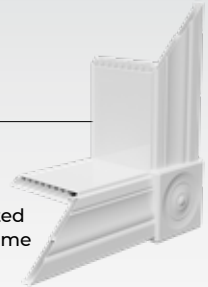

PVC corner mould with extension, frame and rosette

Extension available in 5 3/4", 7", or 10"

Frame available in 2 1/2" or 3 3/8"

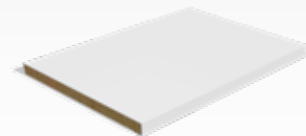

Pine or PVC-cladded wood extension in 5 5/8" or 9 1/4"

1 1/4" TRIPLE PANE

Triple with argon gas and one Low-E

Triple with argon gas and two Low-E



DOORS

NEW DESIGNS

DOOR PANEL



VOG



LINEA



SOHO



SYDNEY



2 PANEL
CAMBER TOP



ERA



TAO



OSO



2 PANEL PLANKED
CAMBER TOP



VICTORIA SHAKER

NEW PRODUCT

COMMODITIES

DOOR PANELS

FLUSH



LONDON

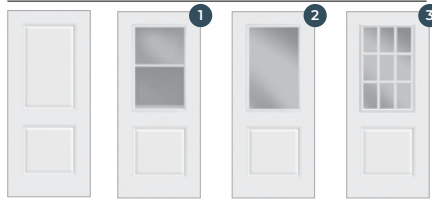

3 PANELS



ORLEANS



SIDLIGHT PANELS

FLUSH

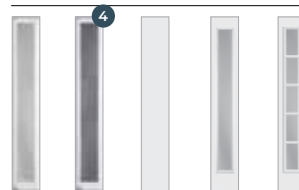



3 PANELS



38

- 1 Hung with Low-E argon glass
- 2 Low-E argon glass
- 3 Low-E argon glass with grills
- 4 One-sided Pinhead Morocco glass (standard)

OUR MODELS







	 SINGLE	 TWIN	 CHÂTEAU
20 YEAR WARRANTY	✓	✓	✓
AVAILABLE FRAMES:			
1 1/4 x 4 5/8 1 1/4 x 6 5/8 1 1/4 x 9 1/4	✓	✓	
1 5/8 x 6 7/16 1 1/4 x 7 1/4	✓	✓	✓
FRAME CLADDING:			
VINYL AND/OR ALUMINIUM	✓	✓	✓
OTHER FEATURES:			
NUMBER OF STEEL DOORS	1	2 OPENINGS	2 (1 FIXED AND 1 OPENING)
DOOR WINDOW WITH ENERGY EFFICIENT GLASS LOW-E ARGON	✓	✓	✓
SCREEN DOOR		OPTIONAL	✓
WHITE POLYFLEX WEATHER STRIPPING ON THREE SIDES	✓	✓	✓
WHITE MAGNETIC WEATHER STRIPPING WITH COMPRESSION	✓	✓	✓
PROTECTIVE VINYL STRIP WITH BRUSH SEAL (REDUCED RISK OF AIR INFILTRATION)	✓	✓	✓
ANODISED ALUMINIUM SILL	✓	✓	✓

Included: 3 hinges, screwed adjustable bottom sweep with screw cap, brushed weather stripping along the bottom edge of the door, all factory-installed on every door. The grooving for the plates on the door slab and frame and handle holes are made at the factory. 1 3/4" superior quality 24-gauge steel door.

STRUCTURAL ASSEMBLY

All measurements are in inches

doors

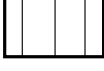
	DOOR	EXTERIOR FRAME SIZE EXTERIOR AND INTERIOR VINYL CLADDED						
		1 1/4 x 4 5/8 - 6 5/8		1 5/8 x 6 7/16		1 1/4 x 7 1/4 - 9 1/4		
SINGLE DOOR			1 1/4 x 4 5/8 - 6 5/8		1 5/8 x 6 7/16		1 1/4 x 7 1/4 - 9 1/4	
		32	33 1/2	82 1/2	34 3/8	82 7/8	33 1/2	82 1/2
		34	35 1/2	82 1/2	36 3/8	82 7/8	35 1/2	82 1/2
SINGLE DOOR + 1 SIDELIGHT (A)			1 1/4 x 4 5/8 - 6 5/8		1 5/8 x 6 7/16		1 1/4 x 7 1/4 - 9 1/4	
		32	48 1/4	82 1/2	49 1/8	82 7/8	48 1/4	82 1/2
		34	50 1/4	82 1/2	51 1/8	82 7/8	50 1/4	82 1/2
SINGLE DOOR + 2 SIDELIGHTS (A)			1 1/4 x 4 5/8 - 6 5/8		1 5/8 x 6 7/16		1 1/4 x 7 1/4 - 9 1/4	
		32	62 7/8	82 1/2	63 3/4	82 7/8	62 7/8	82 1/2
		34	64 7/8	82 1/2	65 3/4	82 7/8	64 7/8	82 1/2
DOUBLE DOOR (B)			1 1/4 x 4 5/8 - 6 5/8		1 5/8 x 6 7/16		1 1/4 x 7 1/4 - 9 1/4	
		32	66 1/4	82 1/2	67 1/8	82 7/8	66 1/4	82 1/2
		34	70 1/4	82 1/2	71 1/8	82 7/8	70 1/4	82 1/2
CHÂTEAU II DOOR C-100					1 5/8 x 6 7/16		1 1/4 x 7 1/4	
		32			67	82 7/8	66 1/8	82 1/2
		34			71	82 7/8	70 1/8	82 1/2
CHÂTEAU II DOOR C-200					1 5/8 x 6 7/16		1 1/4 x 7 1/4	
		28			59	79 5/8	58 1/8	79 5/16
		34			71	79 5/8	70 1/8	79 5/16
CHÂTEAU II DOOR C-100 (C) + 1 FIXED SIDELIGHT					1 5/8 x 6 7/16		1 1/4 x 7 1/4 - 9 1/4	
		32			81 5/8	82 7/8	80 3/4	82 1/2
		34			85 5/8	82 7/8	84 3/4	82 1/2
CHÂTEAU II DOOR C-100 (C) + 2 FIXED SIDELIGHTS					1 5/8 x 6 7/16		1 1/4 x 7 1/4 - 9 1/4	
		32			96 1/4	82 7/8	95 3/8	82 1/2
		34			100 1/4	82 7/8	99 3/8	82 1/2
		36			104 1/4	82 7/8	103 3/8	82 1/2

- Height and width tolerance + or - 1/8"
- Door height (slab) 79"
- For adapted sill, deduct 1 1/2" in height

LEGEND

- (A) For an opening sidelite, add 1/8" in width
- (B) One opening door and one half-opening door
- (C) Screen available with mullion extension

QUALITY MADE BY ROBERGE

DOOR MULLION

100% cellular PVC mullion, no risk of degradation, allowing for structural assembly

Improved appearance

Less caulking joints, greatly reducing the risk of water infiltration

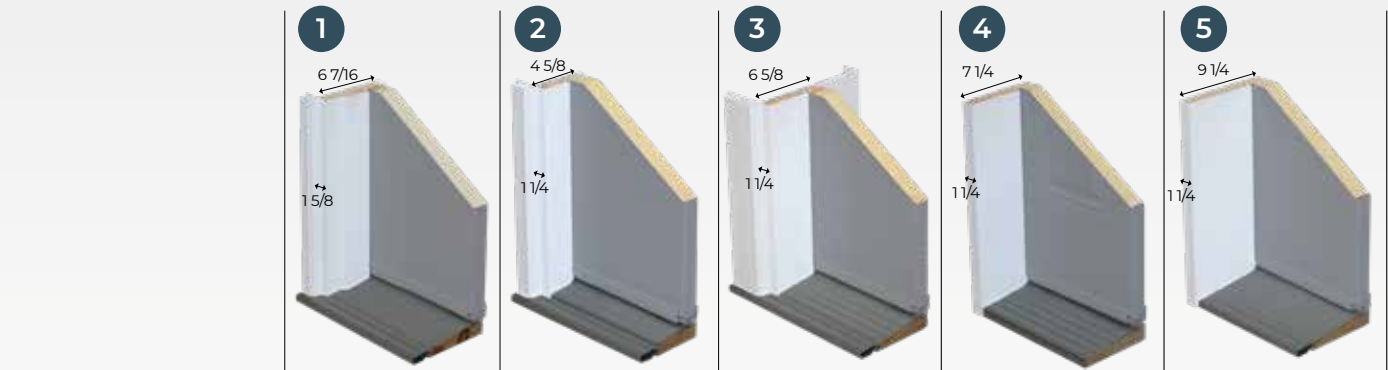
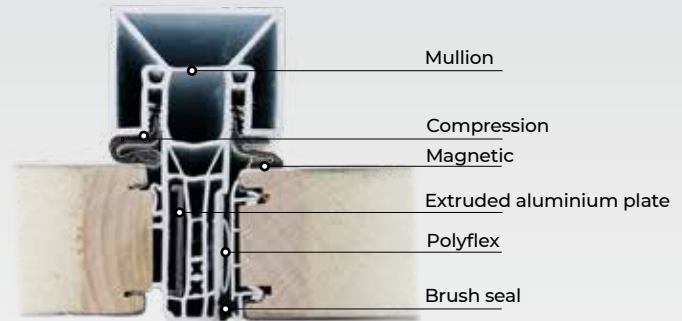

SIZES	1 5/8" x 6 7/16"	1 1/4" x 4 5/8"	1 1/4" x 6 5/8"	1 1/4" x 7 1/4"	1 1/4" x 9 1/4"
OPTIONS	1 1/8" BRICKMOULD (REFERENCE: MODEL 1)	✓	✓	✓	✓
	2" BRICKMOULD (REFERENCE: MODEL 2)	✓	✓	✓	✓
	4" BRICKMOULD (REFERENCE: MODEL 3)	✓	✓	✓	✓
	DRYWALL	1/2" et 3/4"	1/2"	1/2"	1/2"

1 1/8" Brickmould



2" Brickmould



4" Brickmould



WEATHER STRIPPING

Thermal breakage and door sweep to prevent water and air infiltration.

Weather stripping ensures watertightness and A3 tested for air infiltration.

Double weather stripping adapted to counteract winter cold, magnetic on handle side and head, compression on hinged side and Polyflex on 3 sides and on the bottom, with well-positioned brushed weather stripping.



EXTENSIONS

Frame available in 2 1/2" and 3 3/8"
Extension available in 5 3/4" and 7"



Rosette



2 1/2" frame



3 3/8" frame



5 3/4" extension



7" extension

MULTI-LOCK DOOR

Includes multipoint lock and handle (optional)



TOP AND BOTTOM BOLTS

Offers security and prevents forced entry
 Helps to prevent air infiltration
 Helps to prevent door warping

EXTERIOR OPTIONS

White vinyl cladding
 1 1/8" colonial brickmould (see image of frame 1 on p. 13)
 2" colonial brickmould (see image of frame 2 on p. 13)
 4" colonial brickmould (see image of frame 3 on p. 13)
 1 9/16" contemporary brickmould
 White or painted aluminium cladding
 1 1/8" aluminium brickmould in brown, black, or colored

INTERIOR OPTIONS

Interior vinyl cladding
 J moulding (optional, when interior extension is required)

DECORATIVE GLASS

Enhance your door with a decorative glass insert to personalize it to the style of your home. Choose from a wide variety of decorative glass options (see our selection p. 15 to 20).

MULTIPOINT HANDLES

CHOICE OF DESIGNS

Alegro contemporary



Capri



COLORS

DOORS

Your door can be painted, with the possibility of different colors on each side. Choose from a wide variety of available colors (see p. 26).



BALL BEARING HINGES AND MULTIPOINT HANDLES

Satin chrome Laiton poli Antique brass



Satin nickel Oil brushed Pewter Black enamelled

HINGES (COLORS AND DESIGNS)

REGULAR HINGES (STANDARD)

Silver



SPRING HINGES (OPTIONAL)

Chrome or brass finished



BALL BEARING HINGES (OPTIONAL)

Available with or without steeple tips



DECORATIVE GLASS

Novatech®



LOUISBOURG

Louisbourg's elegant geometry evokes glass etchings. The asymmetrical grid creates a striking dynamic composition.

OUR PRODUCTS

A door glass has to withstand the tests of time. Since our beginnings in decorative glass manufacturing, we've integrated new materials and processes to develop innovative technologies and attractive designs.

Our products are designed to help you create warm, inviting spaces that you'll enjoy coming back to night after night.

Many other models available
Consult grouphenovatech.com.



AZUR

With its contemporary or eclectic style, this glass is suitable for both retrofit and new construction projects.



SOFT*

Soft attracts the eye and the touch with its unconventional pattern



MISTRAL

Elegant Art-Nouveau style
Simple, slender shapes



OPAL

A rich arrangement of bevelled glass in a timeless style



CÉLESTE

A geometric pattern with a refined and balanced light effect

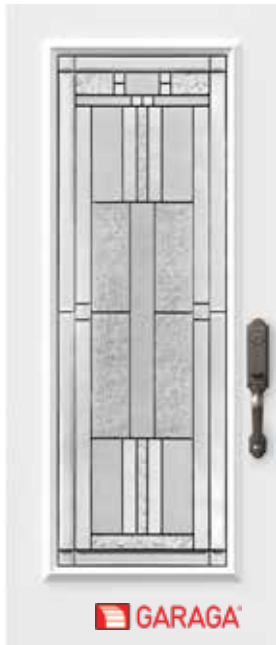

CACHET*

Blends four striking textures to make your home stand out



WINCHESTER

Sleek and balanced, the Winchester offers a rich and contrasting blend of satin, clear glass, and black polished rods



MASTERLINE*

A modern design with alternating strips of polished glass and Screen glass



LIANO

This stylish decorative glass is a new take on a classic look



ALLURE

With its assertive jewelled central floral element, Allure never fails to impress



ARUM

Thin intersecting diagonal lines create an intimate pattern that changes depending on your point of view

decorative glass



ALYS

This design evokes movement, with its style that is both natural and abstract



CHANELLE

Adds a stately, elegant, and timeless touch to any home, classic or modern



BISTRO

With its arched central piece crowned by bevelled clear glass, it offers a consistently classic and natural look

decorative glass



OUR COMPANY

Verre Select stands out as a leader in the decorative glass industry. Through an efficient network of distributors, we've assisted customers in their renovation and construction projects for the past 37 years.

Known for our quality products, we create the current trends by constantly expanding our product range to make your home distinctive, comfortable, and personalized. Our innovative ideas ensure that you're always getting the most recent, original, and exclusive products.

Verre Select, the partner for your projects and ideas

Many other models available
Consult verreselect.com.



JAVA
Contemporary Collection



CORDUROY
Contemporary Collection
Glass size: 23" x 9"



GABRIELLA
Contemporary
Collection



MATHEUS
Classic Collection



AMADEUS
Contemporary Collection



CINDY
Classic Collection



WHISTLER
Classic Collection



CADENCE
Contemporary Collection

decorative glass



QUATTRO
Classic Collection



RYU
Contemporary Collection



LINEA
Contemporary and Classic
Collection



FRAGRANCE
Contemporary Collection



NAOMI
Contemporary Collection



SHIRAZ
Contemporary Collection

PATIO DOORS

Novatech®

550

The 550 door combines the sturdiness of wood with the durability of PVC. With its PVC panels welded to the narrow framework, this door lets in more light and enhances your living space. Its outstanding maintenance-free finish makes it perfect for renovation projects. Installation is easy thanks to the reinforced wood/PVC frame.



patio doors

Low-E 80/70 on surface 3

Energy efficiency: 34

U factor: 1.70

Air filtration resistance: A3

Water resistance: 400 Pa / B4

Wind resistance: C3

Ease of operation test: E3

Resistance to forced entries: F2

Uniform structural load: DP 45

Overall: PG-R45

Harmonised standards AAMA/WDMA/CSA101/I.S.2/A440-08

Canadian standards CAN/CGSB-82.1-M89

Reference: 71" x 81" door

Exterior view
X = Opening sash
O = Fixed sash

5'



59½" x 79½"
58½" x 81"

6'



71½" x 79½"
70½" x 81"
71½" x 95½"

7' & 8'



95½" x 79½"
82½" x 81"
94½" x 81"
94½" x 95½"
95½" x 95½"

9' & 12'



105" x 79½"
104⅞" x 81"
139⅜" x 81"

9' & 12'



107⅜" x 79½"
105⅝" x 81"
141⅝" x 81"
9' door XOO or OOX
available upon request

10' & 12'



116⅞" x 79½"
140½" x 79½"
114½" x 81"
138⅞" x 81"
140½" x 95½"



IMAGINE

SLIDING GARDEN DOOR

This has all the charm of a garden door without the inconveniences of a swinging door. The large glass surfaces give this sliding door a classic look that lets you arrange the interior and exterior of your home without obstruction. Complement your patio door with one of our decorative options, such as a grille or integrated mini-blinds.

portes patio



Low-E 80/70 on surface 3

Energy efficiency: 28

U factor: 1.76

Air filtration resistance: A3

Water resistance: 400 Pa/B4

Wind resistance: C3

Ease of operation test: E3

Resistance to forced entries: F2

Uniform structural load: DP 45

Overall: PG-R45

Harmonised standards AAMA/WDMA/CSA101/I.S.2/A440-08

Canadian standards CAN/CGSB-82.1-M89

Reference: 71 1/2" x 81 1/2" door

Exterior view
X = Opening sash
O = Fixed sash

5'



59 1/2" x 79 1/2"
58 1/2" x 81"

6'



71 1/2" x 79 1/2"
70 1/2" x 81"

8'

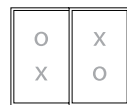

95 1/2" x 79 1/2"
94 1/2" x 81"

9'



104" x 79 1/2"
102 7/16" x 81"

9'



107 7/8" x 79 1/2"
106 7/16" x 81"

9' door XOO or OOX
available upon request

10' & 12'



116 1/2" x 79 1/2"
114 5/8" x 81"
140 9/16" x 79 1/2"
138 11/16" x 81"



ELEMENT

HYBRID PATIO DOOR

The Element door combines the energy efficiency of PVC with the unequalled sturdiness of aluminium exterior cladding. This door comes in a wide range of colors so you can match it to your decor, no matter what the style, at no additional charge.



patio doors

Low-E 80/70 on surface 3

Energy efficiency: 32

U factor: 1.76

Air filtration resistance: A3

Water resistance: 400 Pa / B4

Wind resistance: C3

Ease of operation test: E3

Resistance to forced entries: F2

Uniform structural load: DP 50

Overall: PG-R50

Harmonised standards AAMA/WDMA/CSA101/I.S.2/A440-08

Canadian standards CAN/CGSB-82.1-M89

Reference: 71 1/2" x 81" door

Exterior view
X = Opening sash
O = Fixed sash

5'



59 1/2" x 79 1/2"
58 1/2" x 81"
59 1/2" x 95 1/2"

6'



71 1/2" x 79 1/2"
70 1/2" x 81"
71 1/2" x 95 1/2"

7' & 8'



95 1/2" x 79 1/2"
82 1/2" x 81"
94 1/2" x 81"
95 1/2" x 95 1/2"

9' & 12'



105" x 79 1/2"
103 7/8" x 81"
105" x 95 1/2"
139 3/8" x 81"

9' & 12'



107 7/8" x 79 1/2"
105 5/8" x 81"
141 1/8" x 81"
107 7/8" x 95 1/2"

9' door XOO or OOX
available upon request

10' & 12'



116 7/8" x 79 1/2"
140 1/2" x 79 1/2"
114 1/2" x 81"
138 7/8" x 81"
116 7/8" x 95 1/2"
140 1/2" x 95 1/2"

URBANIA

SLIDING ALUMINIUM DOOR

Enjoy your living space to the fullest with a door that makes the outdoors a natural extension of your living space. With its oversized panels and narrow frames, the Urbania door offers a panoramic view that will open up your home. It is durable, sturdy, and maintenance free, especially for colored doors.









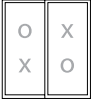

Low-E 80/70 on surface 3
Energy efficiency: 31
U factor: 1.87

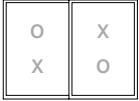
Air filtration resistance: A3
Water resistance: DP 50 / 360 Pa
Uniform structural load: LC 40 without reinforcement, CW 60 with reinforcement

Harmonised standards AAMA/WDMA/CSA101/I.S.2/A440-08
 Reference: 95 1/2" x 95 1/2" door



Exterior view X = Opening sash O = Fixed sash	5'  59 1/2" x 79 1/2" 58 1/2" x 81" 59 1/2" x 95 1/2"	6'  71 1/2" x 79 1/2" 70 1/2" x 81" 71 1/2" x 95 1/2"	8'  95 1/2" x 79 1/2" 94 1/2" x 81" 95 1/2" x 95 1/2"	9'  107" x 79 1/2" 107" x 81" 107" x 95 1/2"
	Asymmetric opening pane available left or right   Available left or right	7'  83 1/2" x 79 1/2" 82 1/2" x 81" 83 1/2" x 95 1/2" 3' (36") opening sash	8'  95 1/4" x 79 1/2" 94 3/4" x 81" 95 1/4" x 95 1/2" 3' (36") opening sash	9'  107 1/4" x 79 1/2" 106 3/4" x 81" 107 1/4" x 95 1/2" 3' (36") opening sash



LOFT

ALUMINIUM TILT'N'SLIDE DOOR

With its effortless operation, the oversized opening panel of the Loft door creates a seamless vision between the interior and the exterior that opens up your home. The Loft's lift-and-slide system allows the manufacture of large patio doors with only two panels. This design frees your field of vision from any unnecessary mullions.



Low-E 80/70 on surface 3
Energy efficiency: 31
U factor: 1.87

Air filtration resistance: A3
Water resistance: DP 50 / 360 Pa
Uniform structural load: LC 40 without reinforcement, CW 60 with reinforcement

Harmonised standards AAMA/WDMA/CSA101/I.S.2/A440-08
 Reference: 95 1/2" x 95 1/2" door

patio doors



Exterior view
 X = Opening sash
 O = Fixed sash

6'



71 1/2" x 79 1/2"
 70 1/2" x 81"
 71 1/2" x 95 1/2"

8'

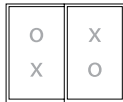

95 1/2" x 79 1/2"
 94 1/2" x 81"
 95 1/2" x 95 1/2"

9'

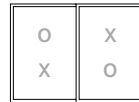

107" x 79 1/2"
 107" x 81"
 107" x 95 1/2"

10'

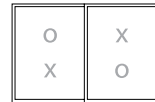

119" x 79 1/2"
 119" x 81"
 119" x 95 1/2"

12'



143" x 79 1/2"
 143" x 81"
 143" x 95 1/2"

Asymmetric opening pane
 available left or right



Available
 left or right

7'



83 1/2" x 79 1/2"
 82 1/2" x 81"
 83 1/2" x 95 1/2"

3' (36") opening
 sash

8'



95 1/4" x 79 1/2"
 94 3/4" x 81"
 95 1/4" x 95 1/2"

3' (36") opening
 sash

9'



107 1/4" x 79 1/2"
 106 3/4" x 81"
 107 1/4" x 95 1/2"

3' (36") opening
 sash

10'



119 1/4" x 79 1/2"
 118 3/4" x 81"
 119 1/4" x 95 1/2"

4' (48") opening
 sash

CUSTOM COLORS

WE DO THE PAINTING!

Roberge has its own paint shop in Abitibi, where we paint PVC or hybrid doors and windows. Offered in a wide range of colors and completely manufactured in the region, our products blend perfectly into your most colorful projects.

We use high-end reflective paint combined with conveniently located air cavities on the profiles to preserve the contraction/dilation properties of the PVC.

PVC

Our PVC extrusions are manufactured from white resin. We also offer 20 fashion colors that we've specially selected for you.

POPULAR COLORS*



HYBRID

We offer two standard colors for the hybrid model: black and commercial brown. We also offer 18 fashion colors that we've specially selected for you.

Looking for an exact color to perfectly blend your doors and windows with your decor?
Roberge also offers the possibility of painting them in the color of your choice and can add other colors according to your needs.

* Colors for display purposes only



WARRANTIES AND CERTIFICATIONS

THE ROBERGE WARRANTY

SUMMARY*

WHITE PVC WINDOWS

20 YEARS - extruded PVC

PAINTED PVC AND ALUMINIUM WINDOWS

10 YEARS - extruded PVC and aluminium

LIMITED WARRANTY: SEALED UNIT

20 YEARS - condensation or dust deposits between the panes

TRANSFERRABLE WARRANTY

10 YEARS - from delivery date

PARTS AND LABOUR

1 YEAR - following purchase

HARDWARE AND PARTS

10 YEARS - casement and awning windows, ball bearing hinges

5 YEARS - sliding and hung windows, multipoint handles



* For more details and to find out the conditions, consult our Roberge warranty certificate on our website.

THE ENERGY STAR ADVANTAGE

Roberge is proud to announce that all of its window products, sold with Low-E argon **HER** Thermopane and Technoform spacers, are **ENERGY STAR** certified.

Roberge's windows are among the most energy-efficient products on the market. They offer reduced energy consumption, enhanced comfort, reduced exterior noise, less condensation in cold weather conditions, and maximum UV filtration to protect your furniture and floors.

ENERGY STAR is the international symbol of energy efficiency.





\ HEAD OFFICE

10, avenue Des Chênes
La Sarre (Quebec)
J9Z 3C6

Phone: 819-333-4877
Toll-free: 1-800-567-6446
Fax: 1-800-808-9195

\ GATINEAU

573, boulevard Maloney Est
Gatineau (Quebec)
J8P 1E9

Phone: 819-246-0375
Toll-free: 1-866-663-9011
Fax: 819-663-2178

\ NEPEAN

1891, Merivale Road
Nepean (Ontario)
K2G 1E5

Phone: 613-224-1917
Toll-free: 1-855-224-1917
Fax: 613-224-0089

info@roberge1917.com
roberge1917.com

Official Distributor